

DPC-181/183/381/382/383

SERVICE MANUAL

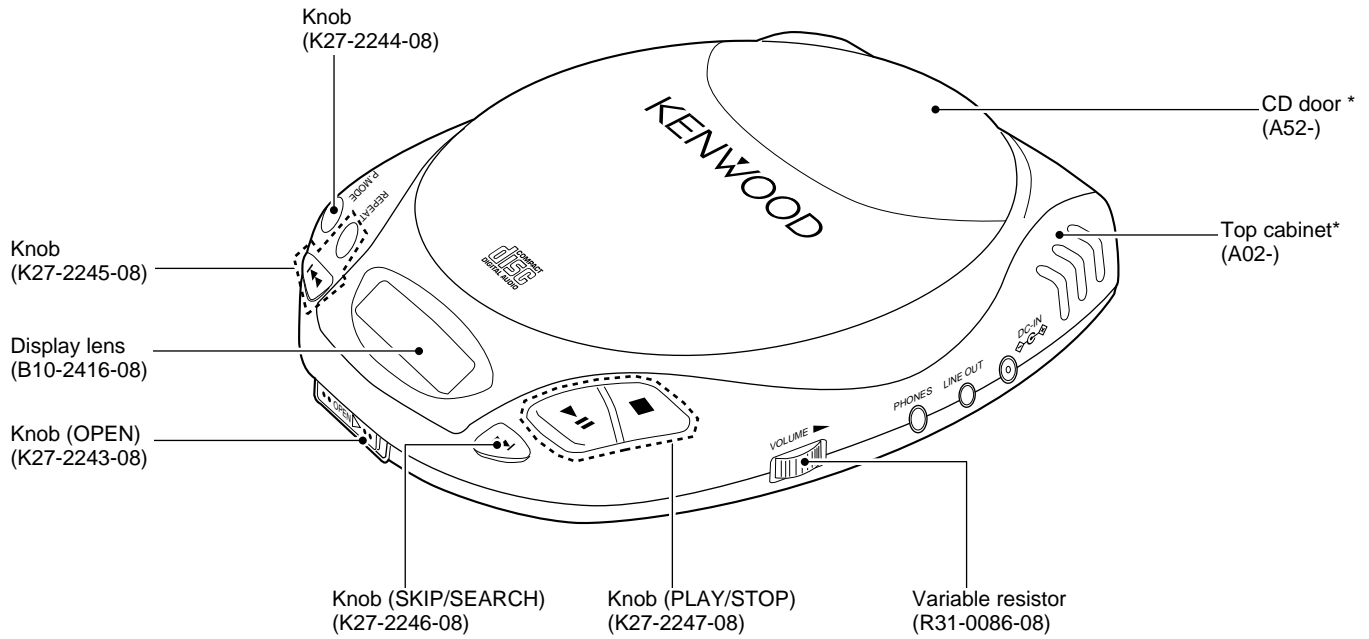

Illust is DPC-181/381/382.

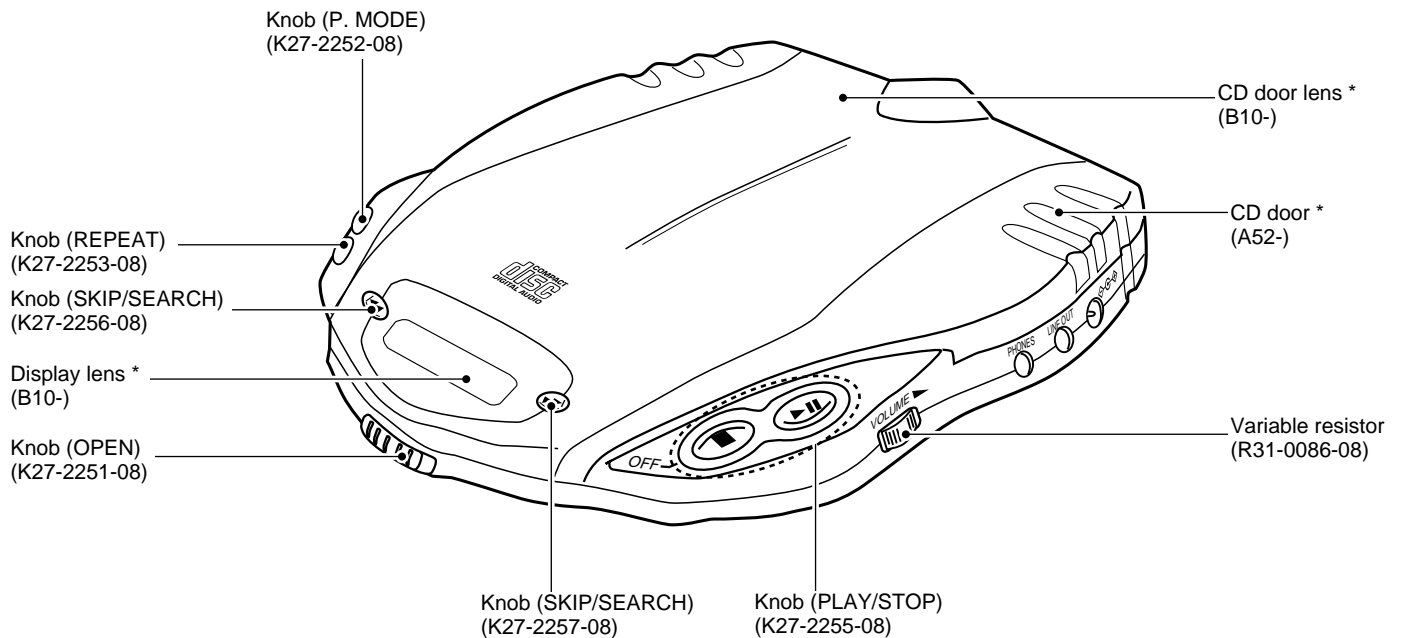

Illust is DPC-183/383.

* Refer to parts list on page 13.

In compliance with Federal Regulations, following are reproductions of labels on, or inside the product relating to laser product safety.

KENWOOD-Corp. certifies this equipment conforms to DHHS Regulations No. 21 CFR 1040. 10, Chapter 1, Subchapter J.

DANGER : Laser radiation when open and interlock defeated. AVOID DIRECT EXPOSURE TO BEAM.

DPC-181/183/381/382/383

CONTENTS / ACCESSORIES

Contents

CONTENTS / ACCESSORIES	2	EXPLODED VIEW	13
CIRCUIT DESCRIPTION	3	PARTS LIST	15
PC BOARD	5	SPECIFICATIONS	19
SCHEMATIC DIAGRAM	9		

Model feature list

MODEL FEATURE	DPC-181							DPC-183					DPC-381						DPC-382						DPC-383						
	K	P	E	T	M	M2	X	K	P	E	T	M	X	K	P	E	T	M	M2	K	P	E	T	M	X	K	P	E	T	M	M2
OPTICAL OUT																			○												
LINE OUT		○	○	○	○	○	○	○	○	○	○	○	○	○	○	○	○	○		○	○	○	○	○	○	○	○	○	○	○	○
REMOTE TERMINAL						○						○						○	○												○
DASC KNOB														○	○	○	○	○	○	○	○	○	○	○	○	○	○	○	○	○	○
B.B KNOB	○	○	○	○	○	○	○	○	○	○	○	○	○																		
B.BOOST P.MODE														○	○	○	○	○	○	○	○	○	○	○	○	○	○	○	○	○	○
P.MODE	○	○	○	○	○	○	○	○	○	○	○	○	○																		

Accessories

AC adapter(110~120V /220-240V 50/60Hz)(1)

(W08-0657-08) : KP
 (W08-0658-08) : E
 (W08-0659-08) : T
 (W08-0660-08) : X
 (W08-0667-05) : M,M2

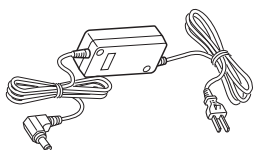

Innerphone.....(1)

(W01-0925-05) : DPC-181(MXTE)
 DPC-183(X)
 DPC-381(TE)
 (W01-0923-05) : DPC-181(M2)
 DPC-183(M)
 DPC-381(M,M2)
 DPC-383(M2)

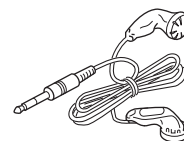

Rechargeable battery(1)

(W09-1239-05) : KP
 (W09-1240-05) : ETMXM2



Remote control.....(1)

(A70-1111-08) : DPC-181 (M2)
 DPC-183 (M)

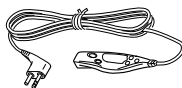

Audio cable(1)

(E30-2782-05) : DPC-381(E.T)



Headphone(1)

(W01-0924-05) : DPC-181(KP)
 (W01-0943-05) : DPC-381(KP)
 (T17-0015-08) : DPC-383(M)
 (T17-0016-08) : DPC-383(KPETX)

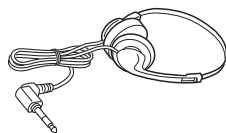

Car cassette adapter.....(1)

(W01-0922-05) : DPC-382

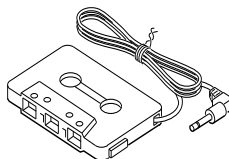

Remote control.....(1)

(A70-1190-05) : DPC-381/383 (M,M2)

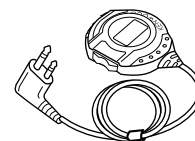

Car battery adapter(1)

(W01-0921-05) : DPC-382

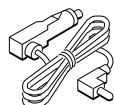

AC plug(1)

(E03-0115-05) : M,M2

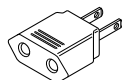

CIRCUIT DESCRIPTION

1. Microprocessor : (MN171603 H3)

1-1 Pin description

Pin No.	Pin name	I/O	Function description	Active
1, 2	–	I	NOT USED	
3	AVSS	–	GND	
4	BBS	O	BBS CONTROL SIGNAL OUTPUT	ON = "H"
5	DATA	O	REMOTE CONTROL SIGNAL OUTPUT	
6, 7	–		NOT USED	
8	KEY	I	KEY INPUT	
9	HOLD	I	HOLD ON/OFF CONTROL	ON = "H"
10	ESP	I	ESP ON/OFF CONTROL	ON = "L"
11	LOW BATTERY	I	BATTERY VOLTAGE DETECTION	LOW BATT. = "H"
12	AVDD	–	SUPPLY VOLTAGE	
13-15	VLC1~VLC3	–	LCD DRIVER BIAS CONTROL	
16-19	COM1~COM4	O	LCD COMMON SIGNAL OUTPUT (COMMON1~4)	
20-33	SEG0~SEG13	O	LCD SEGMENT SIGNAL OUTPUT (SEG0~SEG13)	
34, 35	SEG14, 15	O	NOT USED	
36	MODE-M	I	MEMORY SELECT	4M = "H" OTHER = "L"
37	D-CNT	I	DIGITAL OUT CONTROL	OUT = "H" (ESP OFF)
38	MODE-A	I	USE CUE/REV MODE	
39	MODE-B	I	NOT USED	
40	STDBY	O	NOT USED	
41-44	–	–	NOT USED	
45	DOOR OPEN	I	DOOR SWITCH DETECTION	OPEN = "H"
46	PSET	I	PICKUP INITIAL POSITION	
47	BTCHK	I	BATT. VOLTAGE DIRECTION.	
48-51	–	I	NOT USED	
52	POWER	O	POWER SUPPLY CONTROL.	
53	BAT	O	BATTERY CONTROL OUTPUT	CHARGING = "H"
54	D MUTE	O	MUTE CONTROL	ON = "H"
55	SBCK	O	SUB CODE READ TIMING CLOCK FOR MN662740RE	
56	FCLK	I	FRAME CLOCK SIGNAL from MN662740RE	
57	FLAG	I	FLAG SIGNAL INPUT from MN662740RE	
58	IPFLAG	I	CORRECTION = "H"	
59	–	I	GND	
60	STAT	I	STATUS SIGNAL from DSP	
61	SENSE	I	SENSITIVE SIGNAL from DSP	
62	TLOCK	I	TRACKING SERVO	IN = "L"
63	FLOCK	I	FOCUSING SERVO	IN = "L"
64	MCLK	O	COMMAND CLOCK for MN662740RE	
65	MDATA	O	COMMAND DATA for MN662740RE	
66	MLD	O	COMMAND DATA LATCH (LOAD) for MN662740RE	
67	–	O	NOT USED	
68	RST	I	SYSTEM RESET INPUT	
69	X1	I	GND	
70	X2	O	NOT USED	
71	Vss	–	GND	
72	–	O	NOT USED	
73	SMCK	I	EXTERNAL SYSTEM CLOCK = 4.2336MHz	

DPC-181/183/381/382/383

CIRCUIT DESCRIPTION

Pin No.	Pin name	I/O	Function description	Active
74	VDD	-	SUPPLY VOLTAGE (ESP ON = 4.2V / OFF = 3.2V)	
75	LRST	O	RESET SIGNAL for MN662740RE, SM5859AF	
76	SQCK	O	SUBQ READ TIMING CLOCK to MN662740RE	
77	SUBQ	I	SUBQ DATA from MN 662740RE	
78	-	O	NOT USED	
79	YMLD	O	COMMAND DATA LATCH (LOAD) for SM5859AF	
80	YMCLK	O	COMMAND CLOCK for SM5859AF	
81	ZSENSE	I	SENSITIVE SIGNAL from SM5859AF	
82	YMDATA	O	COMMAND DATA for SM5859AF	
83	BLKCK	I	SUBQ READ REQUEST SIGNAL IN.	
84	-	I	GND	

1-2 Voltage of pin No. 8 (IC3) / Key function.

KEY	V	Key of unit (Remocon)
	0.00	PLAY/PAUSE (▶/⏸)
	0.75	STOP (■)
	1.00	UP (▶▶)
	1.23	B. BOOST / P. MODE
	1.43	DOWN (◀◀)
	1.69	REPEAT
	2.13	MUTE (Only Remocon)
	2.55	KEY OFF
	3.0	

1-3 Microprocessor periphery block diagram

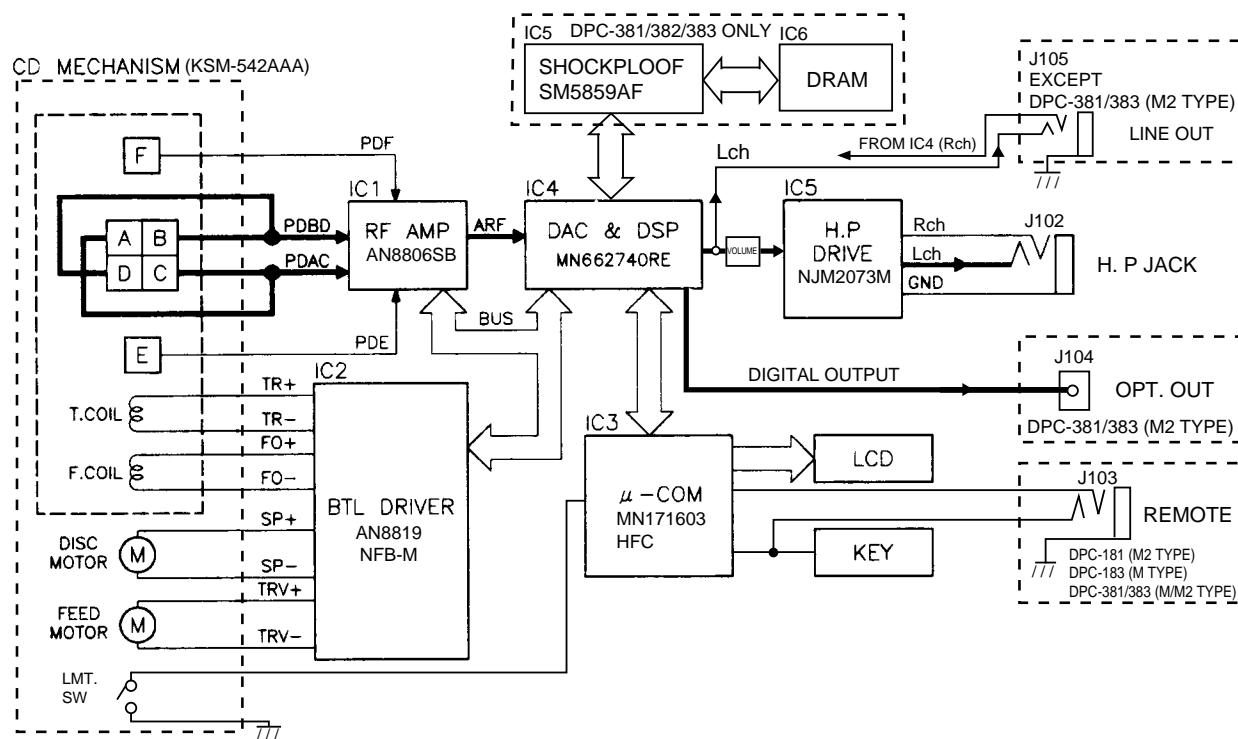

PC BOARD(Component side view) : DPC-181/381/382

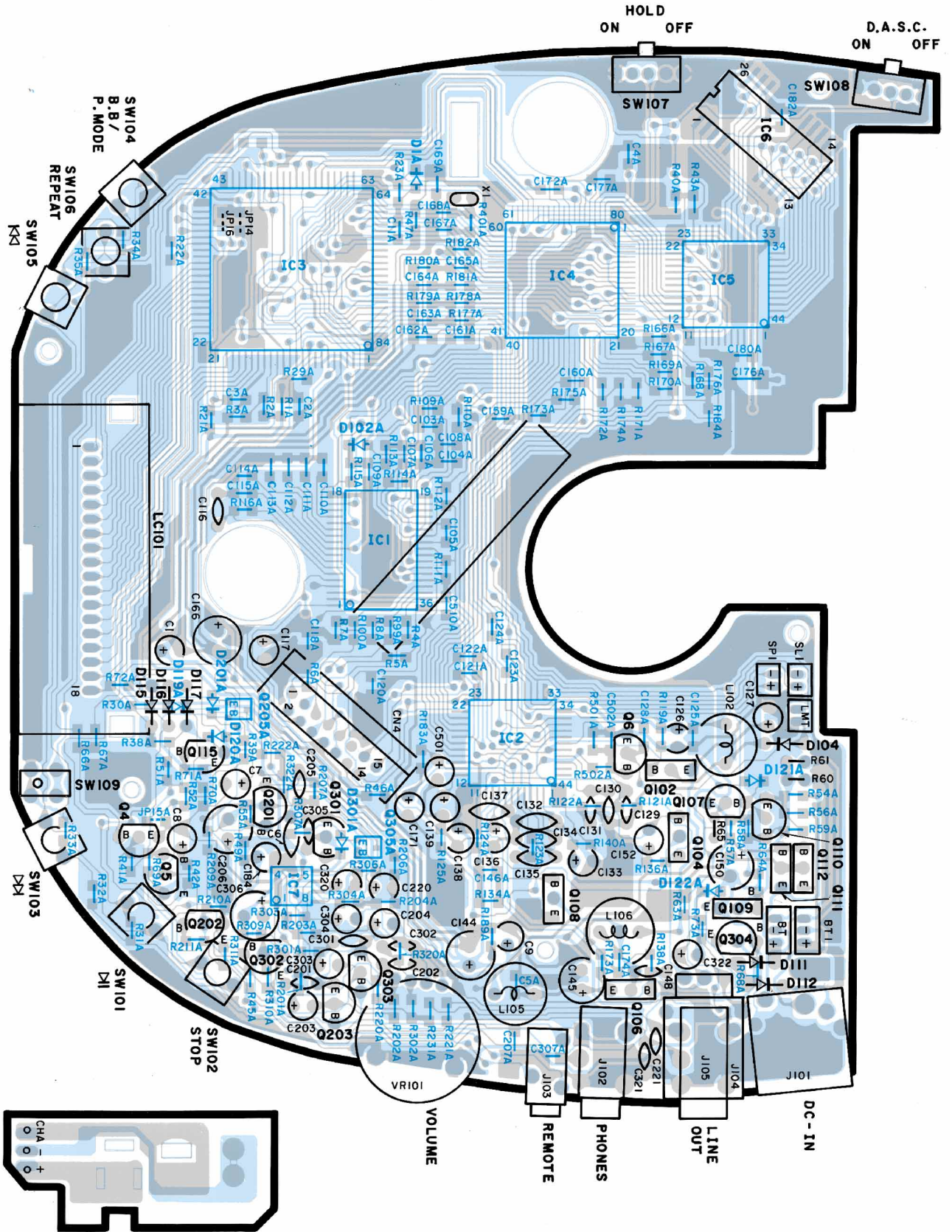

Refer to the schematic diagram for the value of resistors and capacitors.

PC BOARD(Foil side view) : DPC-181/381/382

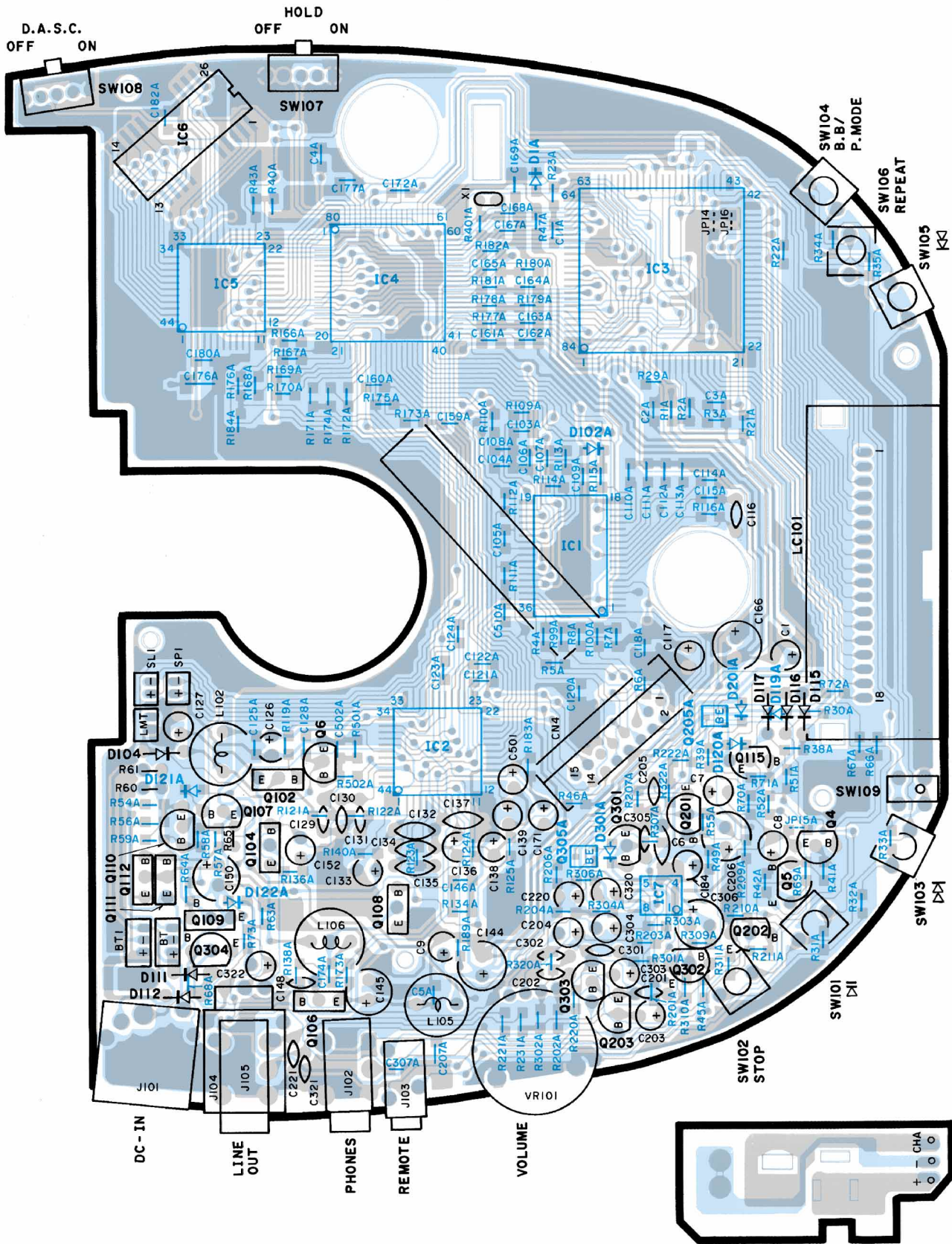

Refer to the schematic diagram for the value of resistors and capacitors.

PC BOARD(Component side view) : DPC-183/383

PC BOARD(Foil side view) : DPC-183/383

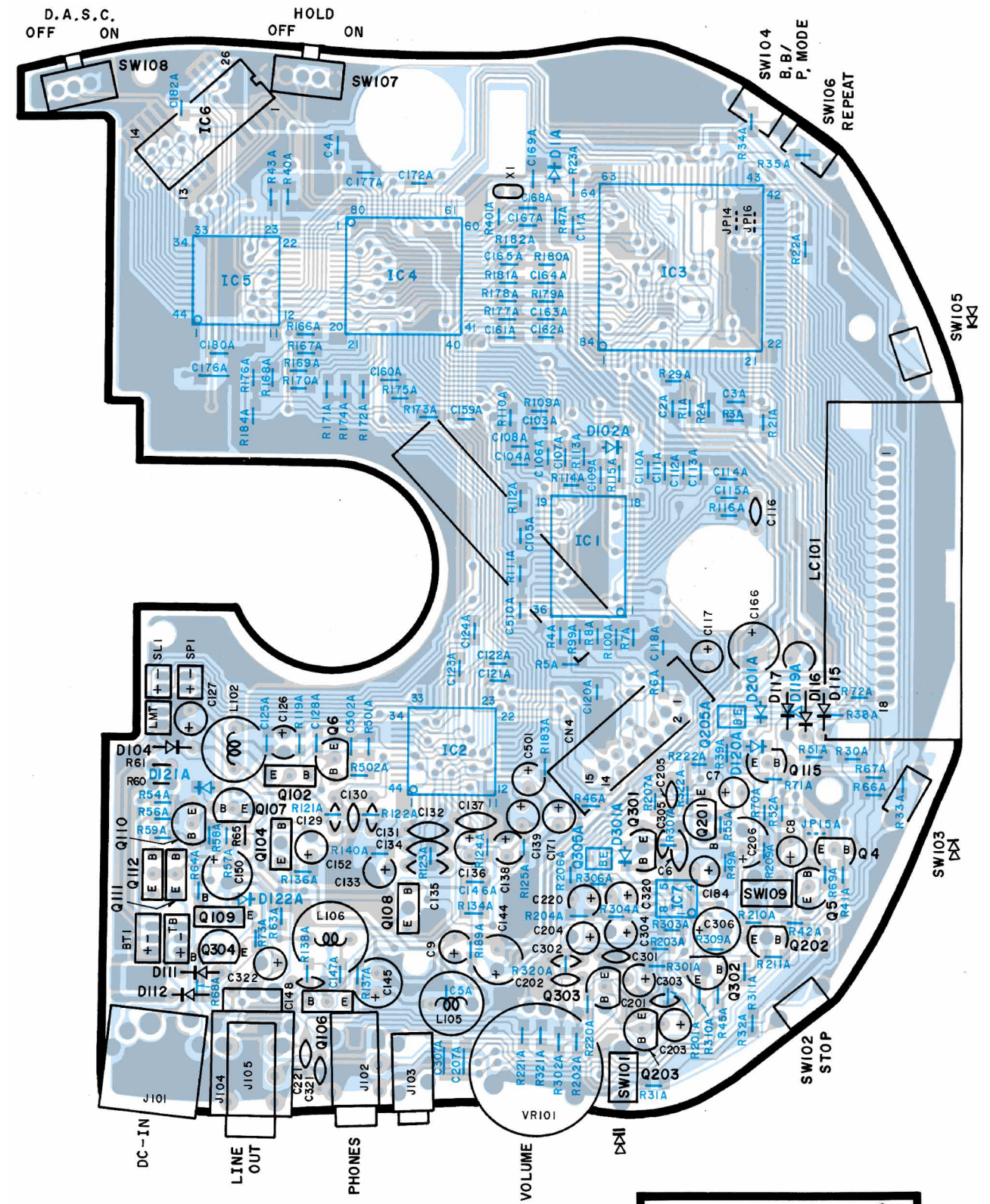
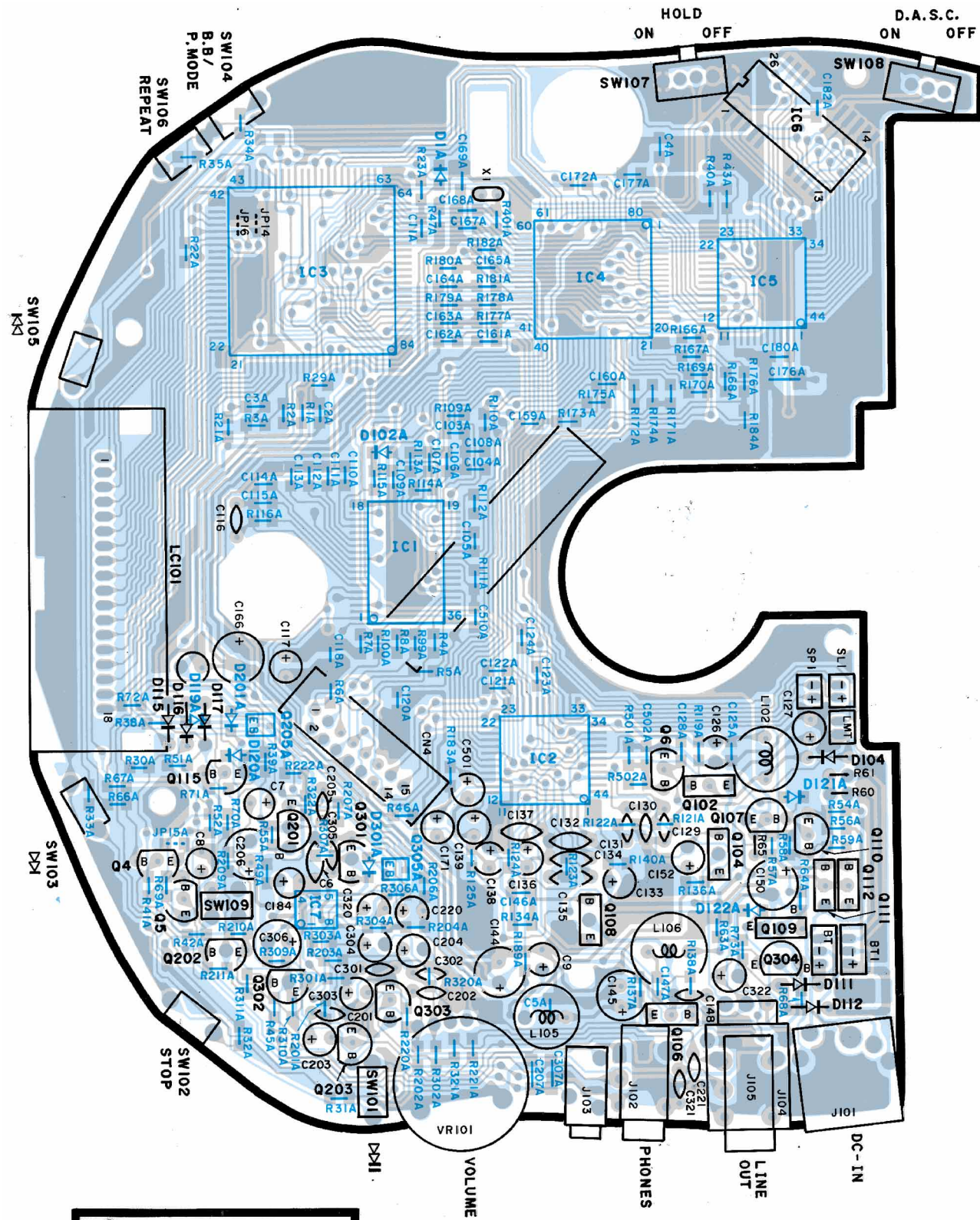

Refer to the schematic diagram for the value of resistors and capacitors.

MECHA. ASS'Y

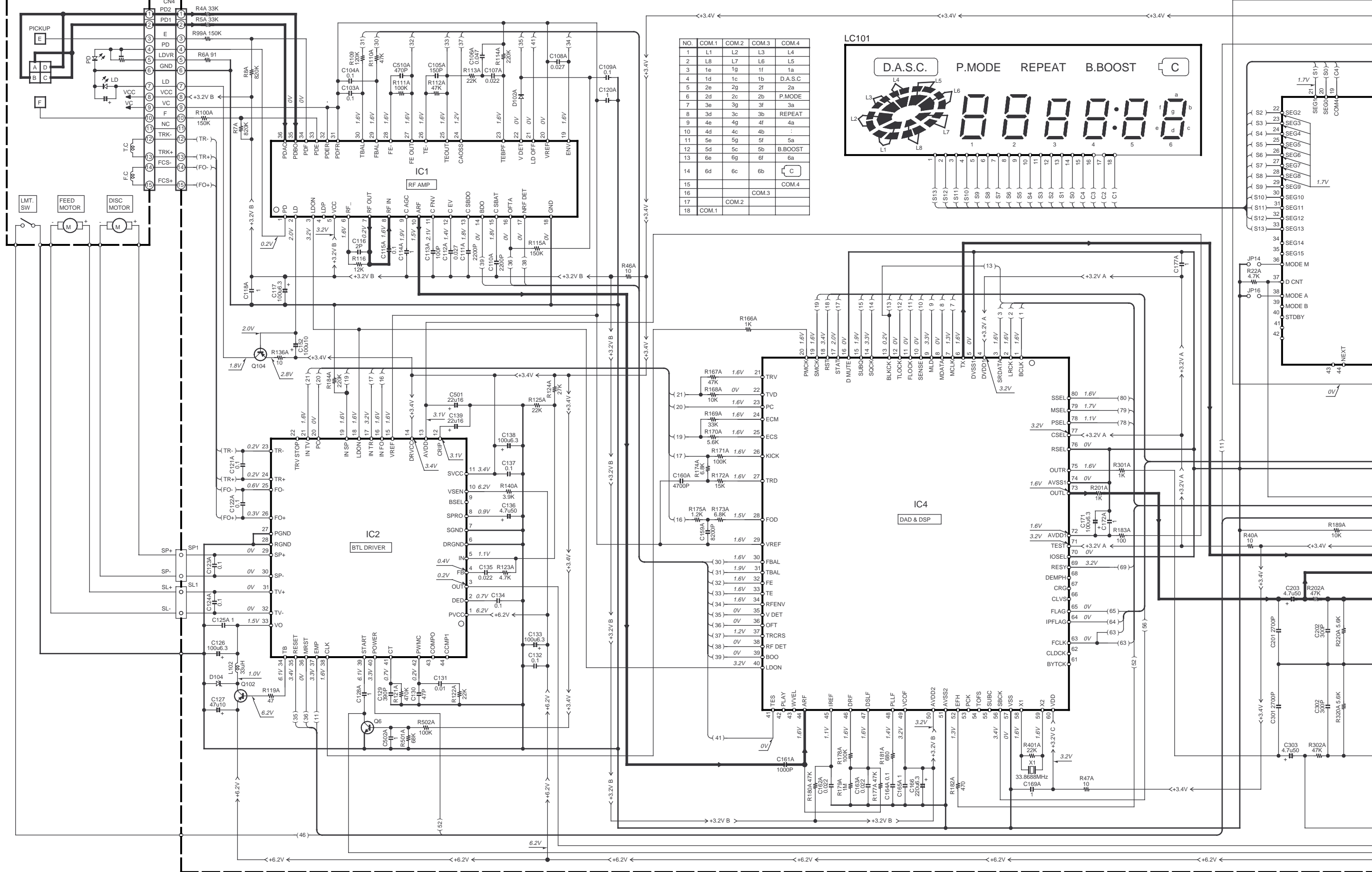

NO.	COM.1	COM.2	COM.3	COM.4
1	L1	L2	L3	L4
2	L8	L7	L6	L5
3	1e	1g	1f	1a
4	1d	1c	1b	D.A.S.C
5	2e	2g	2f	2a
6	2d	2c	2b	P.MODE
7	3e	3g	3f	3a
8	3d	3c	3b	REPEAT
9	4e	4g	4f	4a
10	4d	4c	4b	:
11	5e	5g	5f	5a
12	5d	5c	5b	B.BOOST
13	6e	6g	6f	6a
14	6d	6c	6b	C
15				
16			COM.3	COM.4
17		COM.2		
18	COM.1			

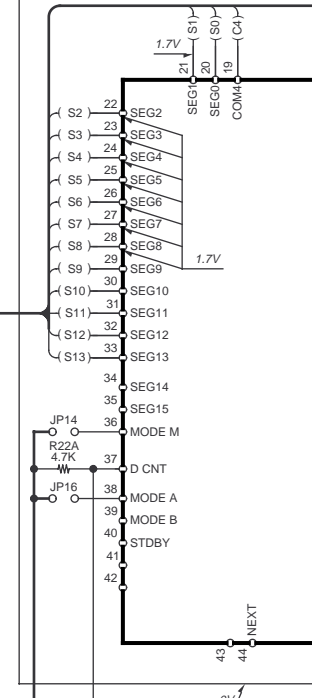
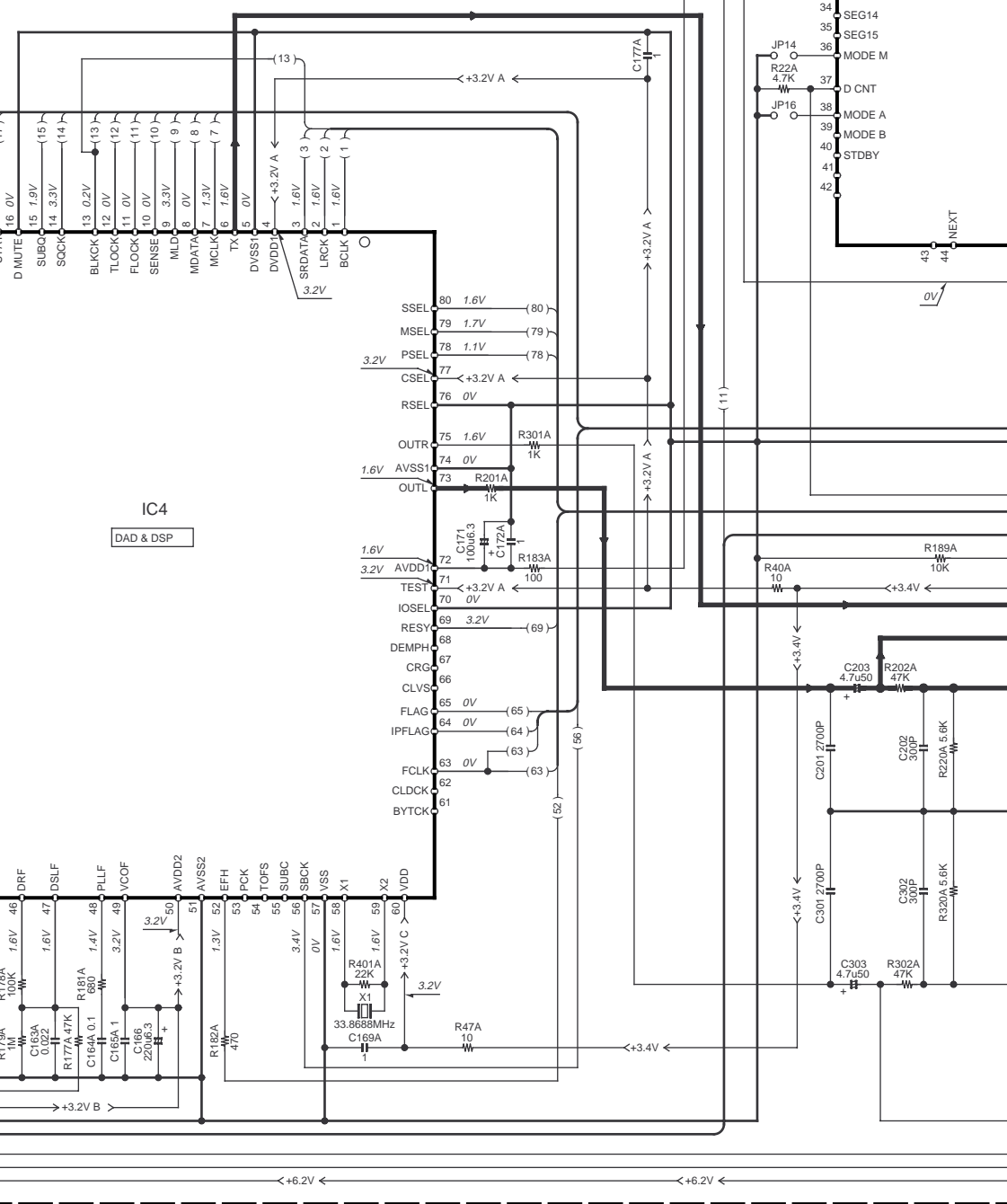
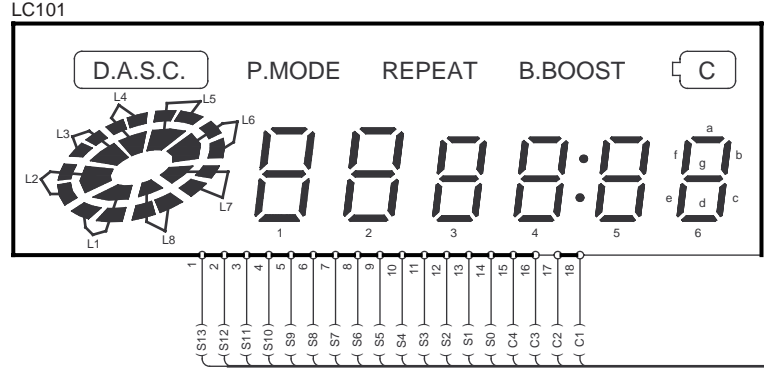

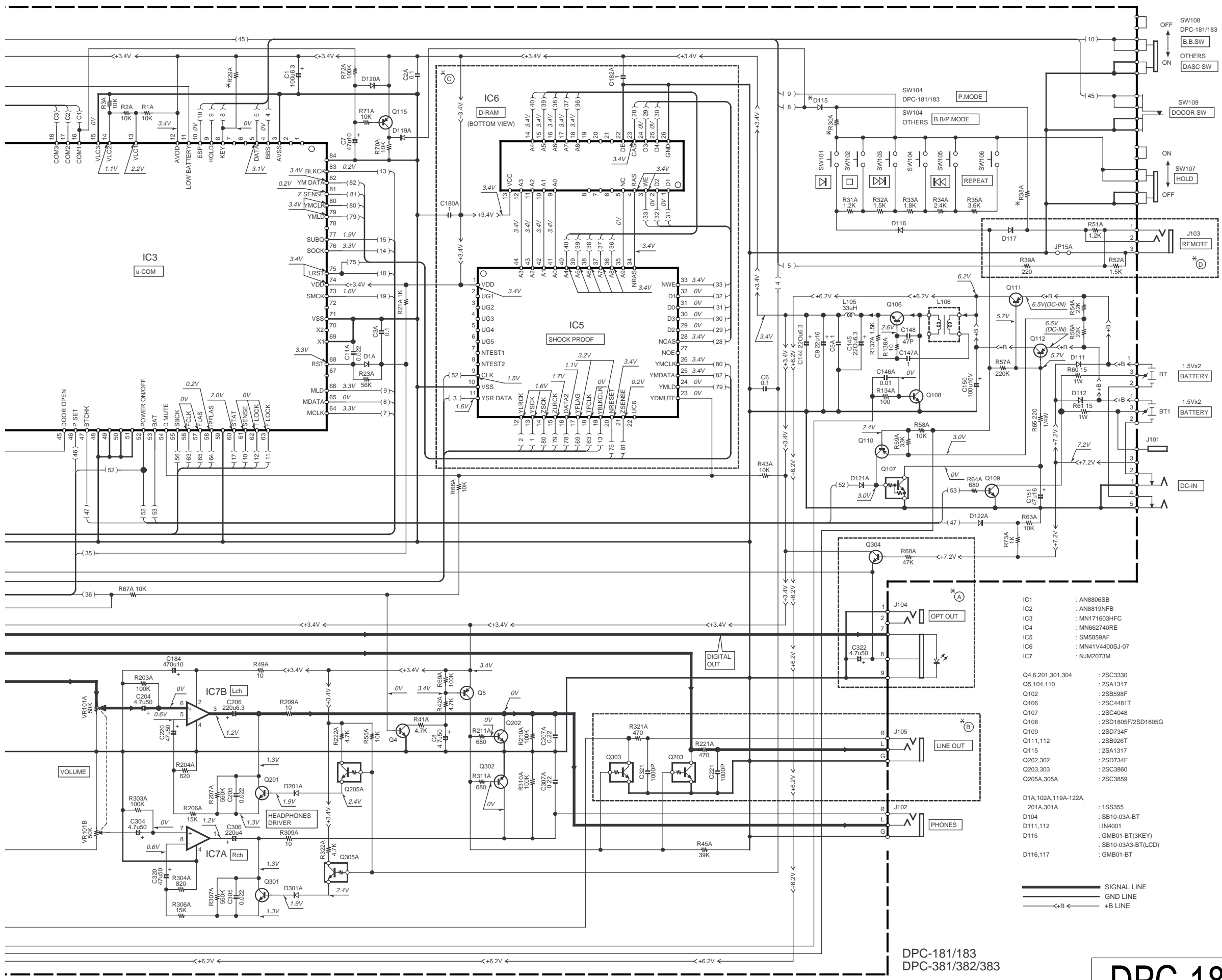

CAUTION: For continued safety, replace safety critical components only with manufacturer's recommended parts (refer to parts list). Δ indicates safety critical components. For continued protection against risk of fire, replace only with same type and rating fuse(s). To reduce the risk of electric shock, leakage-current or resistance measurements shall be carried out (exposed parts are acceptably insulated from the supply circuit) before the appliance is returned to the customer.

The DC voltage is an actual reading measured with a high impedance type voltmeter. The measurement value may vary depending on the measuring instruments used or on the product. Refer to the voltage during PLAY with DASC OFF (at the normal speed) unless otherwise specified; The value shown in () is the voltage measured at the moment of STOP.

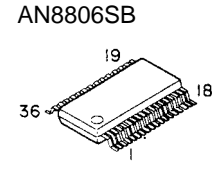

- IC1 : AN8806SB
 - IC2 : AN8819NFB
 - IC3 : MN171603HFC
 - IC4 : MN662740RE
 - IC5 : SM5859AF
 - IC6 : MN41V4400SJ-07
 - IC7 : NJM2073M
- Q4,6,201,301,304 : 2SC3330
 - Q5,104,110 : 2SA1317
 - Q102 : 2SB598F
 - Q106 : 2SC4481T
 - Q107 : 2SC4048
 - Q108 : 2SD1805F/2SD1805G
 - Q109 : 2SD734F
 - Q111,112 : 2SB926T
 - Q115 : 2SA1317
 - Q202,302 : 2SD734F
 - Q203,303 : 2SC3860
 - Q205A,305A : 2SC3859
- D1A,102A,119A-122A, 201A,301A : 1SS355
 - D104 : SB10-03A-BT
 - D111,112 : 1N4001
 - D115 : GMB01-BT(3KEY)
 - D116,117 : SB10-03A3-BT(LCD)
 - : GMB01-BT

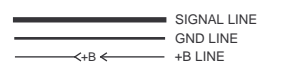

DPC-181		(A)	(B)	(C)	(D)	D115	R29A	R30A, R38A
DESTINATION	ABB							
COUNTRY	ABB							
U.S.A.	K							
CANADA	P							
EUROPE	E	NO	YES		NO	NO	NO	NO
U.K.	T							
AUSTRALIA	X							
GENERAL MARKET	M				YES	GMB01-BT	10K	0
GENERAL MARKET	M2							

DPC-183		(A)	(B)	(C)	(D)	D115	R29A	R30A, R38A
DESTINATION	ABB							
COUNTRY	ABB							
U.S.A.	K							
CANADA	P							
EUROPE	E	NO	YES		NO	NO	NO	NO
U.K.	T							
AUSTRALIA	X							
GENERAL MARKET	M				YES	GMB01-BT	10K	0
GENERAL MARKET	M2							

DPC-381		(A)	(B)	(C)	(D)	D115	R29A	R30A	R38A
DESTINATION	ABB								
COUNTRY	ABB								
U.S.A.	K								
CANADA	P								
EUROPE	E	NO	YES	YES	NO	NO	NO	NO	NO
U.K.	T								
AUSTRALIA	X								
GENERAL MARKET	M				YES	SB10-03A	8.2K	1K	820
GENERAL MARKET	M2	YES	NO						

DPC-382		(A)	(B)	(C)	(D)	D115	R29A,30A, 38A
DESTINATION	ABB						
COUNTRY	ABB						
U.S.A.	K						
CANADA	P						
EUROPE	E	NO	YES		NO	NO	NO
U.K.	T						
AUSTRALIA	X						
GENERAL MARKET	M				YES	SB10-03A	8.2K
GENERAL MARKET	M2	YES	NO				

DPC-383		(A)	(B)	(C)	(D)	D115	R29A	R30A	R38A
DESTINATION	ABB								
COUNTRY	ABB								
U.S.A.	K								
CANADA	P								
EUROPE	E	NO	YES		NO	NO	NO	NO	NO
U.K.	T								
AUSTRALIA	X								
GENERAL MARKET	M				YES	SB10-03A	8.2K	1K	820
GENERAL MARKET	M2	YES	NO						

DPC-181/183
DPC-381/382/383

DPC-181/183/381/382/383

Y22-7250-11

KENWOOD

DPC-181/183/381/382/383

EXPLODED VIEW(UNIT)

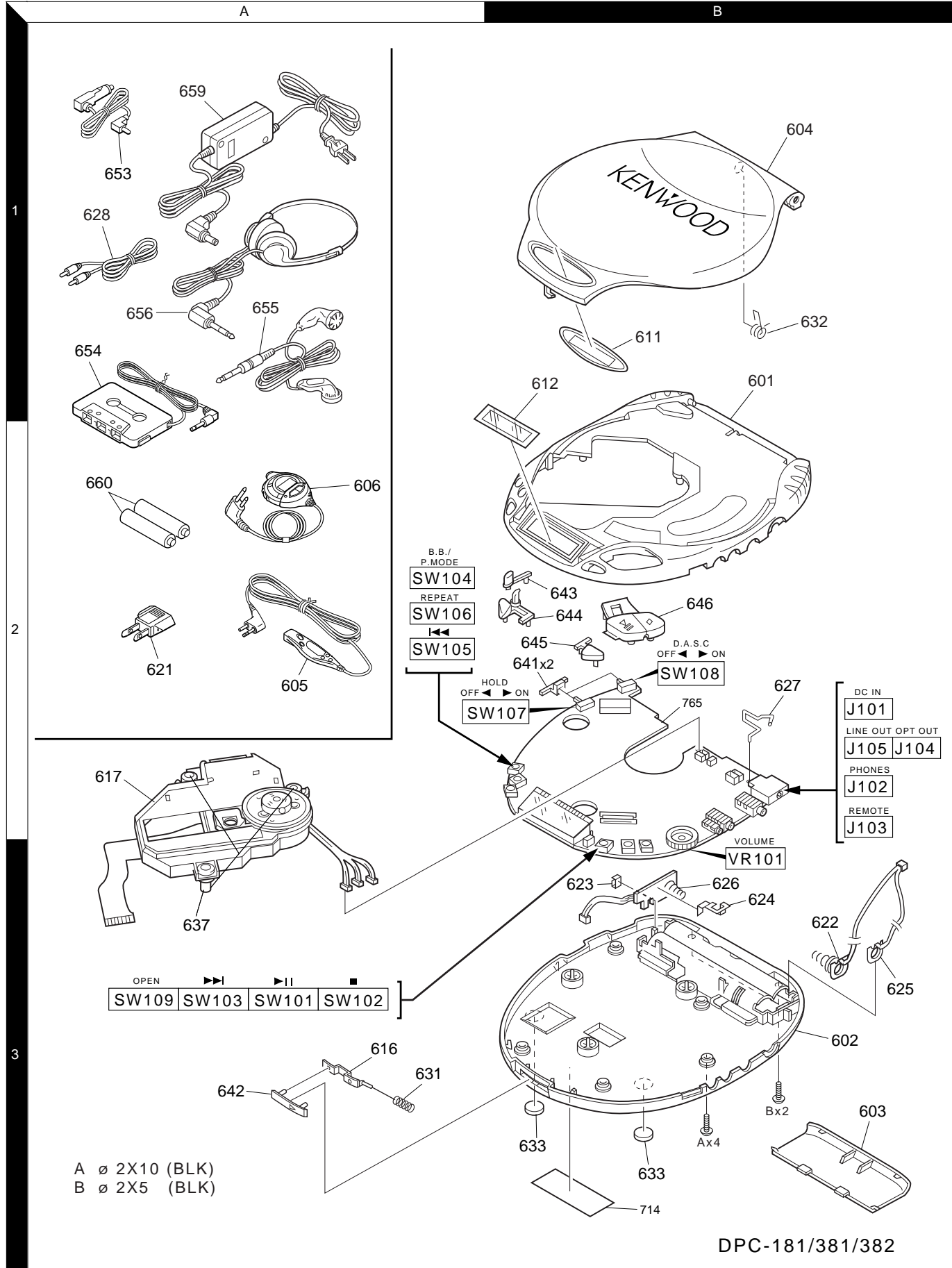

A \varnothing 2X10 (BLK)
 B \varnothing 2X5 (BLK)

DPC-181/381/382

Parts with exploded view numbers larger than 700 are not supplied.

DPC-181/183/381/382/383

EXPLODED VIEW(UNIT)

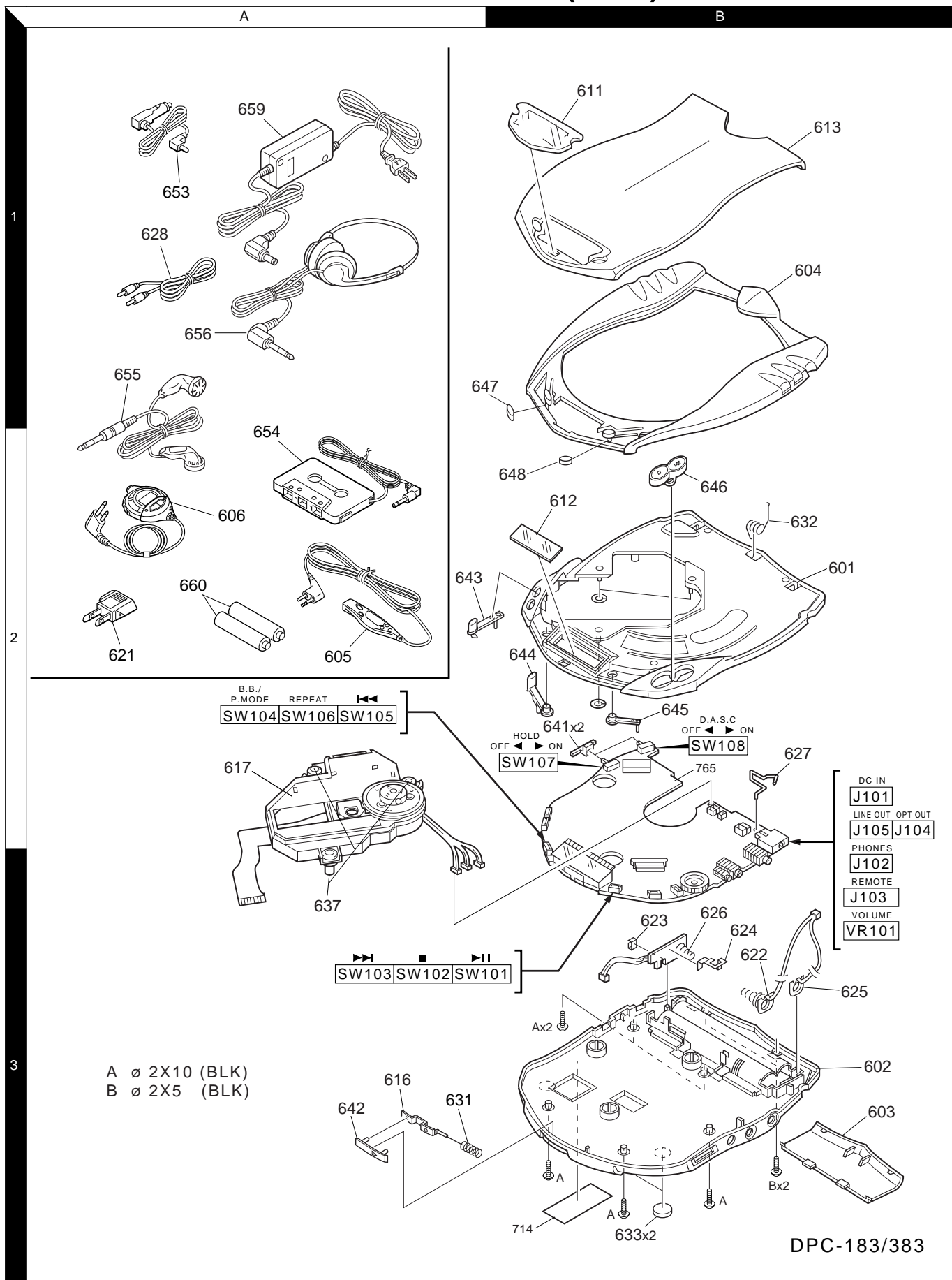

Parts with exploded view numbers larger than 700 are not supplied.

* New Parts
 Parts without **Parts No.** are not supplied.
 Les articles non mentionnés dans le **Parts No.** ne sont pas fournis.
 Teile ohne **Parts No.** werden nicht geliefert.

①

Ref. No	Add-ress	New Parts	Parts No.	Description	Desti-nation	Re-marks
DPC-181/183/381/382/383						
601	1B	*	A02-XXXX-08	TOP CABINET DPC-181	M2	1
601	2B	*	A02-2805-08	TOP CABINET DPC-383	M	5
601	1B	*	A02-1375-08	TOP CABINET DPC-381	KPET	3
601	1B	*	A02-1383-08	TOP CABINET DPC-381	M	3
601	1B	*	A02-1384-08	TOP CABINET DPC-381	M2	3
601	1B	*	A02-1386-08	TOP CABINET DPC-382		4
601	1B	*	A02-1387-08	TOP CABINET DPC-181	KP	1
601	1B	*	A02-1388-08	TOP CABINET DPC-181	ETX	1
601	1B	*	A02-1389-08	TOP CABINET DPC-181	M	1
601	2B	*	A02-1393-08	TOP CABINET DPC-183	KP	2
601	2B	*	A02-1397-08	TOP CABINET DPC-383	ETX	5
601	2B	*	A02-1394-08	TOP CABINET DPC-183	ETX	2
601	2B	*	A02-1397-08	TOP CABINET DPC-383	KP	5
601	2B	*	A02-2804-08	TOP CABINET DPC-383	M2	5
601	2B	*	A02-2806-08	TOP CABINET DPC-183	M	2
602	3B	*	A02-1400-08	BOTTOM CABINET DPC-381	M2	3
602	3B	*	A02-1385-08	BOTTOM CABINET DPC-181	M	1
602	3B	*	A02-1390-08	BOTTOM CABINET DPC-181	KP	1
602	3B	*	A02-1392-08	BOTTOM CABINET DPC-181	ETX	1
602	3B	*	A02-1395-08	BOTTOM CABINET DPC-383	KP	5
602	3B	*	A02-1395-08	BOTTOM CABINET DPC-183/383	ETX	2,5
602	3B	*	A02-1396-08	BOTTOM CABINET DPC-183	M	2
602	3B	*	A02-1399-08	BOTTOM CABINET DPC-383	M2	5
602	3B	*	A02-1396-08	BOTTOM CABINET DPC-383	M	5
602	3B	*	A02-2803-08	BOTTOM CABINET DPC-381	KPETX	3
602	3B	*	A02-2803-08	BOTTOM CABINET DPC-382		4
602	3B	*	A02-XXXX-08	BOTTOM CABINET DPC-181	M2	1
602	3B	*	A02-2801-08	BOTTOM CABINET DPC-381	M	3
602	3B	*	A02-2802-08	BOTTOM CABINET DPC-183	KP	2
603	3B	*	A09-0389-08	BATTERY DOOR DPC-181		1
603	3B	*	A09-0392-08	BATTERY DOOR DPC-381/382		2,3
603	3B	*	A09-0394-08	BATTERY DOOR DPC-183/383		2,5
604	1B	*	A52-0328-08	CD DOOR DPC-181		1
604	1B	*	A52-0329-08	CD DOOR DPC-183/383	ETXMM2	2,5
604	1B	*	A52-0330-08	CD DOOR DPC-183	KP	2
604	1B	*	A52-0330-08	CD DOOR DPC-383	KP	5
604	1B	*	A52-0332-08	CD DOOR DPC-381		3
604	1B	*	A52-0333-08	CD DOOR DPC-382		4
605	2A	*	A70-1111-08	3KEY REMOCON DPC-181	M2	1
605	2A	*	A70-1111-08	3KEY REMOCON DPC-183	M	2
606	2A	*	A70-1190-05	LCD REMOCON DPC-381/383	M,M2	3,5
611	1B	*	B10-2416-08	DISPLAY LENS DPC-181/381/382		1,2,3
611	1B	*	B10-2430-08	DISPLAY LENS DPC-183		2
611	1B	*	B10-2433-08	DISPLAY LENS DPC-383		5
612	1B	*	B10-2417-08	INNER DISP LENS DPC-181/381/382		1,2,3
612	2B	*	B10-2431-08	INNER DISP LENS DPC-183/383		2,5
613	1B	*	B10-2438-08	CD DOOR LENS DPC-183	ETXM	2
613	1B	*	B10-2432-08	CD DOOR LENS DPC-183	KP	2
613	1B	*	B10-2434-08	CD DOOR LENS DPC-383	KP	5
613	1B	*	B10-2437-08	CD DOOR LENS DPC-383	ETXMM2	5
-		*	B46-0100-50	WARRANTY CARD	XTE	
-		*	B46-0332-03	WARRANTY CARD	K	
-		*	B46-0336-03	WARRANTY CARD	P	
-		*	B58-1519-08	CAUTION SHEET(HOLD)		

L : Scandinavia K : USA P : Canada R : Mexico 1 : DPC-181 2 : DPC-183
 Y : PX(Far East, Hawaii) T : Europe E : Europe G : Germany 3 : DPC-381 4 : DPC-382
 Y : AAFES(Europe) X : Australia M : Other Areas
 XXXX : No available the parts number.

⚠ indicates safety critical components.

* New Parts
 Parts without **Parts No.** are not supplied.
 Les articles non mentionnés dans le **Parts No.** ne sont pas fournis.
 Teile ohne **Parts No.** werden nicht geliefert.

②

Ref. No	Add-ress	New Parts	Parts No.	Description	Desti-nation	Re-marks
-		*	B60-3358-08	INST MANUAL(EN)DPC-181/381/382	KP	
-		*	B60-3359-08	INST MANUAL(EN)DPC-181/381/382	TMX	
-		*	B60-3360-08	INST MANUAL(SP)DPC-181/381/382	EM	
-		*	B60-3361-08	INST MANUAL(F) DPC-181/381/382	PE	
-		*	B60-3362-08	INST MANUAL(G) DPC-181/381/382	E	
-		*	B60-3363-08	INST MANUAL(D) DPC-181/381/382	E	
-		*	B60-3364-08	INST MANUAL(I) DPC-181/381/382	E	
-		*	B60-3365-08	INST MANUAL(C) DPC-181/381/382	M	
-		*	B60-3366-08	INST MANUAL(TA)DPC-181/381/382	M	
-		*	B60-3368-08	INST MANUAL(EN)DPC-383	KP	
-		*	B60-3369-08	INST MANUAL(EN)DPC-383	TMX	
-		*	B60-3370-08	INST MANUAL(SP)DPC-383	EM	
-		*	B60-3371-08	INST MANUAL(F) DPC-383	PE	
-		*	B60-3372-08	INST MANUAL(G) DPC-383	E	
-		*	B60-3373-08	INST MANUAL(D) DPC-383	E	
-		*	B60-3374-08	INST MANUAL(I) DPC-383	E	
-		*	B60-3375-08	INST MANUAL(C) DPC-383	M	
-		*	B60-3376-08	INST MANUAL(TA)DPC-383	M	
617	2A		D40-1547-08	CD MECHANISM KSM-542AAA		
621	2A		E03-0115-05	AC PLAG ADAPTER	MM2	
622	3B	*	E23-1737-08	BATTERY CONTACT PLATE(-)		
623	3B	*	E23-1755-08	BATTERY CONTACT SPRING PLATE+		
624	3B	*	E23-1756-08	RECHARGE CONTACT PLATE		
625	3B	*	E23-1758-08	BATTERY CONTACT PLATE(+)		
626	3B	*	E23-1759-08	BATTERY CONTACT SPRING(-)		
627	2B	*	E23-1757-08	RECHARGE CONTACT SPRING		
628	1A	*	E30-2782-05	AUDIO CABLE DPC-381 ET only	ET	
631	3A	*	G01-4037-08	OPEN KNOB SPRING(FOR HOOK)		
632	1B	*	G01-4038-08	CD DOOR SPRING DPC-181/381/382		1,2,3
632	2B	*	G01-4040-08	CD DOOR SPRING DPC-183/383		2,5
633	3B	*	G13-0542-08	RUBBER FOOT DPC-181/381/382		1,2,3
633	3B	*	G13-0562-08	RUBBER FOOT DPC-183/383		2,5
-		*	H25-1603-08	POLYBAG 178X178+60MM		
-		*	H50-2528-08	ITEM CARTON DPC-381	KP	3
-		*	H50-2529-08	ITEM CARTON DPC-381	E	3
-		*	H50-2530-08	ITEM CARTON DPC-381	T	3
-		*	H50-2531-08	ITEM CARTON DPC-381	M	3
-		*	H50-2532-08	ITEM CARTON DPC-381	M2	3
-		*	H50-2534-08	ITEM CARTON DPC-181	M2	1
-		*	H50-2535-08	ITEM CARTON DPC-181	TX	1
-		*	H50-2536-08	ITEM CARTON DPC-181	KP	1
-		*	H50-2537-08	ITEM CARTON DPC-181	E	1
-		*	H50-2538-08	ITEM CARTON DPC-181	M	1
-		*	H50-2539-08	ITEM CARTON DPC-382	KPE	4
-		*	H50-2540-08	ITEM CARTON DPC-382	TX	4
-		*	H50-2541-08	ITEM CARTON DPC-382	M	4
-		*	H50-2542-08	ITEM CARTON DPC-183	KP	2
-		*	H50-2543-08	ITEM CARTON DPC-183	E	2
-		*	H50-2544-08	ITEM CARTON DPC-183	M	2
-		*	H50-2546-08	ITEM CARTON DPC-383	KPTX	5
-		*	H50-2547-08	ITEM CARTON DPC-383	E	5
-		*	H50-2548-08	ITEM CARTON DPC-383	M	5
-		*	H50-2640-08	ITEM CARTON DPC-181	T	1

L : Scandinavia K : USA P : Canada R : Mexico 1 : DPC-181 2 : DPC-183
 Y : PX(Far East, Hawaii) T : Europe E : Europe G : Germany 3 : DPC-381 4 : DPC-382
 Y : AAFES(Europe) X : Australia M : Other Areas
 XXXX : No available the parts number.

⚠ indicates safety critical components.

PARTS LIST

DPC-181/183/381/382/383

* New Parts
 Parts without **Parts No.** are not supplied.
 Les articles non mentionnés dans le **Parts No.** ne sont pas fournis.
 Teile ohne **Parts No.** werden nicht geliefert.

3

Ref. No	Add-ress	New Parts	Parts No.	Description	Desti-nation	Re-marks
-		*	H50-2641-08	ITEM CARTON DPC-181	X	1
-		*	H50-2642-08	ITEM CARTON DPC-383	M2	5
616	3A	*	D10-3770-08	HOOK DPC-181/381/382		1,2,3
616	3A	*	D10-3775-08	HOOK DPC-183/383		2,5
637	3A	*	J02-1185-08	CUSHION(MECHA)		
641	2B	*	K27-2242-08	KNOB SIDE DPC-181/381/382		1,2,3
641	2B	*	K27-2250-08	KNOB SIDE DPC-183/383		2,5
642	2B	*	K27-2243-08	KNOB DOOR OPEN DPC-181/381/382		1,2,3
642	2B	*	K27-2251-08	KNOB DOOR OPEN DPC-183/383		2,5
643	2A,2B	*	K27-2244-08	KNOB CD BUTTO ADPC-181/381/382		1,2,3
643	2A,2B	*	K27-2252-08	KNOB CD BUTTO ADPC-183/383		2,5
644	2B	*	K27-2245-08	KNOB CD BUTTO BDPC-181/381/382		1,2,3
644	2B	*	K27-2253-08	KNOB CD BUTTO BDPC-183/383		2,5
645	2B	*	K27-2246-08	KNOB CD BUTTO CDPC-181/381/382		1,2,3
645	2B	*	K27-2254-08	KNOB CD BUTTO CDPC-183/383		2,5
646	2B	*	K27-2247-08	KNOB CD BUTTO DDCPC-181/381/382		1,2,3
646	2B	*	K27-2255-08	KNOB CD BUTTO DDCPC-183/383		2,5
647	1B	*	K27-2256-08	KNOB SKIP/SEARCH A DPC-183/383		2,5
648	1B	*	K27-2257-08	KNOB SKIO/SEARCH B DPC-183/383		2,5
A			N09-3363-08	SCREW 2X10 BLACK		
B			N09-3362-08	SCREW 2X5 BLACK		
653	1A		W01-0921-05	CAR BATTERY ADAPTER DPC-382		4
654	1A		W01-0922-05	CAR CASSETTE ADAPTER DPC-382		4
655	1A		W01-0923-05	INNER H/P(SHORT) DPC-183/381	M	2,3
655	1A		W01-0923-05	INNER H/P(SHORT) 181/381/383	M2	1,3,5
655	1A		W01-0925-05	INNER H/P(LONG) DPC-181	MXTE	1
655	1A		W01-0925-05	INNER H/P(LONG) DPC-183	X	2
655	1A		W01-0925-05	INNER H/P(LONG) DPC-381	TE	3
656	1A	*	T17-0015-08	SPORTS H/P(SHORT) DPC-383	M	5
656	1A	*	T17-0016-08	SPORT H/P(LONG) DPC-383	X	5
656	1A	*	T17-0016-08	SPORT H/P(LONG) DPC-183/383	KPET	2,5
656	1A		W01-0924-05	OPEN H/P(LOW) DPC-181	KP	1
656	1A		W01-0924-05	OPEN H/P(LOW) DPC-382	KPMTE	4
656	1A	*	W01-0943-05	OPEN H/P(HIGH BLACK) DPC-381	KP	3
659	1A		W08-0657-08	AC-DC ADAPTER	KP	
659	1A		W08-0658-08	AC-DC ADAPTER	E	
659	1A		W08-0659-08	AC-DC ADAPTER	T	
659	1A		W08-0660-08	AC-DC ADAPTER	X	
659	1A		W08-0667-05	AC-DC ADAPTER	M	
660	2A		W09-1239-05	RECHARGEABLE BATTERY	KP	
1,2,3,5						
660	2A		W09-1240-05	RECHARGEABLE BATTERY	TXMM2	
ELECTRIC PARTS						
C1			CE04CW0J101M	ELECTRO 100UF 6.3WV		
C2A ,3A			CK73FB1E104K	CHIP C 0.10UF K		
C5A			CK73FB1H105Z	CHIP C 1.0UF Z		
C6			CK45FB1C104K	CERAMIC 0.10UF K		
C7			CE04CW1A470M	ELECTRO 47UF 10WV		
C8			CE04CW1H4R7M	ELECTRO 4.7UF 50WV		
C9			CE04CW1C220M	ELECTRO 22UF 16WV		
C11A			CK73FB1E223K	CHIP C 0.022UF K		
C103A,104A			CK73FB1E104K	CHIP C 0.10UF K		
C105A			CC73FSL1H151J	CHIP C 150PF J		
C106A			CK73FB1H473K	CHIP C 0.047UF K		

L : Scandinavia K : USA P : Canada R : Mexico 1 : DPC-181 2 : DPC-183
 Y : PX(Far East, Hawaii) T : Europe E : Europe G : Germany 3 : DPC-381 4 : DPC-382
 Y : AAFES(Europe) X : Australia M : Other Areas 5 : DPC-383

⚠ indicates safety critical components.

* New Parts
 Parts without **Parts No.** are not supplied.
 Les articles non mentionnés dans le **Parts No.** ne sont pas fournis.
 Teile ohne **Parts No.** werden nicht geliefert.

4

Ref. No	Add-ress	New Parts	Parts No.	Description	Desti-nation	Re-marks
C107A			CK73FB1E223K	CHIP C 0.022UF K		
C108A			CK73FB1E273K	CHIP C 0.027UF K		
C109A			CK73FB1E104K	CHIP C 0.10UF K		
C110A,111A			CK73FB1H222J	CHIP C 2200PF J		
C112A			CK73FB1E273K	CHIP C 0.027UF K		
C113A			CK73FB1H101J	CHIP C 100PF J		
C114A			CK73FB1H105Z	CHIP C 1.0UF Z		
C115A			CK73FB1E104K	CHIP C 0.10UF K		
C116			CC45FSL1H020J	CERAMIC 2.0PF J		
C117			CE04CW0J101M	ELECTRO 100UF 6.3WV		
C118A			CK73FB1H105Z	CHIP C 1.0UF Z		
C120A			CK73FB1H105Z	CHIP C 1.0UF Z		
C121A-124A			CK73FB1E104K	CHIP C 0.10UF K		
C125A			CK73FB1H105Z	CHIP C 1.0UF Z		
C126A			CE04CW0J101M	ELECTRO 100UF 6.3WV		
C127			CE04CW1A470M	ELECTRO 47UF 10WV		
C128A			CK73FB1H105Z	CHIP C 1.0UF Z		
C129			CC45FSL1H391J	CERAMIC 390PF J		
C130			CC45FSL1H470J	CERAMIC 47PF J		
C131			CK45FB1H103Z	CERAMIC 0.010UF Z		
C132			CK45FB1C104K	CERAMIC 0.10UF K		
C133			CE04CW0J101M	ELECTRO 100UF 6.3WV		
C134			CK45FB1C104K	CERAMIC 0.10UF K		
C135			CK45FB1H223Z	CERAMIC 0.022UF Z		
C136			CE04CW1H4R7M	ELECTRO 4.7UF 50WV		
C137			CK45FB1C104K	CERAMIC 0.10UF K		
C138			CE04CW0J101M	ELECTRO 100UF 6.3WV		
C139			CE04CW1C220M	ELECTRO 22UF 16WV		
C144,145			CE04CW0J221M	ELECTRO 220UF 6.3WV		
C146A			CK73FB1E103K	CHIP C 0.010UF K		
C147A			CK73FB1H105Z	CHIP C 1.0UF Z		
C148			CC45FSL1H470J	CERAMIC 47PF J		
C150			CE04CW1C101M	ELECTRO 100UF 16WV		
C151			CE04CW1C470M	ELECTRO 47UF 16WV		
C152			CE04CW1C101M	ELECTRO 100UF 16WV		
C159A			CK73FB1H822K	CHIP C 8200PF K		
C160A			CK73FB1H472K	CHIP C 4700PF K		
C161A			CK73FB1H102K	CHIP C 1000PF K		
C162A,163A			CK73FB1E223K	CHIP C 0.022UF K		
C164A			CK73FB1E104K	CHIP C 0.10UF K		
C165A			CK73FB1H105Z	CHIP C 1.0UF Z		
C166			CE04CW0J221M	ELECTRO 220UF 6.3WV		
C169A			CK73FB1H105Z	CHIP C 1.0UF Z		
C171			CE04CW0J101M	ELECTRO 100UF 6.3WV		
C172A			CK73FB1H105Z	CHIP C 1.0UF Z		
C177A			CK73FB1H105Z	CHIP C 1.0UF Z		
C180A			CK73FB1H105Z	CHIP C 1.0UF Z		
C182A			CK73FB1H105Z	CHIP C 1.0UF Z		
C184			CE04CW1A471M	ELECTRO 470UF 10WV		
C201			CK45FB1H272K	CERAMIC 2700PF K		
C202			CK45FB1H301J	CERAMIC 300PF J		
C203,204			CE04CW1H4R7M	ELECTRO 4.7UF 50WV		
C205			CK45FB1H223Z	CERAMIC 0.022UF Z		
C206			CE04CW0J221M	ELECTRO 220UF 6.3WV		
C207A			CK73FB1H224Z	CHIP C 0.22UF Z		
C220			CE04CW1A470M	ELECTRO 47UF 10WV		

L : Scandinavia K : USA P : Canada R : Mexico 1 : DPC-181 2 : DPC-183
 Y : PX(Far East, Hawaii) T : Europe E : Europe G : Germany 3 : DPC-381 4 : DPC-382
 Y : AAFES(Europe) X : Australia M : Other Areas 5 : DPC-383

⚠ indicates safety critical components.

* New Parts
 Parts without **Parts No.** are not supplied.
 Les articles non mentionnés dans le **Parts No.** ne sont pas fournis.
 Teile ohne **Parts No.** werden nicht geliefert.

5

Ref. No	Add-ress	New Parts	Parts No.	Description	Desti-nation	Re-marks
C221			CK45FB1H102K	CERAMIC 1000PF K		
C301			CK45FB1H272K	CERAMIC 2700PF K		
C302			CK45FB1H301J	CERAMIC 300PF J		
C303,304			CE04CW1H4R7M	ELECTRO 4.7UF 50WV		
C305			CK45FB1H223Z	CERAMIC 0.022UF Z		
C306			CE04CW0G221M	ELECTRO 220UF 4.0WV		
C307A			CK73FB1H224Z	CHIP C 0.22UF Z		
C320			CE04CW1A470M	ELECTRO 47UF 10WV		
C321			CK45FB1H102K	CERAMIC 1000PF K		
C322			CE04CW1H4R7M	ELECTRO 4.7UF 50WV	M2	5
C501			CE04CW1C220M	ELECTRO 22UF 16WV		
C502A			CK73FB1H105Z	CHIP C 1.0UF Z		
C510A			CK73FB1H471J	CHIP C 470PF J		
BT		*	E35-1995-08	3P J.WIRE(RED/BLACK/WHITE)		
BT1		*	E35-1994-08	2P J.WIRE(ORANGE/BLUE)		
CN4			E60-0005-08	15P		
J105			E11-0354-08	LINE OUT(PHONE JACK)		
J101		*	E03-0356-08	DC JACK		
J102		*	E11-0372-08	PHONE JACK 3.6MM GREEN		
J103		*	E11-0355-08	REMOTE JACK 2.6MM(3 PINS)	M	2,3,5
J103		*	E11-0355-08	REMOTE JACK 2.6MM(3 PINS)	M2	1,3,5
L102		*	L33-0564-08	CHOKE COIL 33UH		
L105		*	L33-0564-08	CHOKE COIL 33UH		
L106		*	L33-0565-08	CHOKE COIL 95UH		
LC101		*	B38-0164-08	LCD DISPLAY		
X1		*	L77-2204-08	CRYSTAL RESONATOR 33.8688MHZ		
R1A -3A			RK73FB2A103J	CHIP R 10K J 1/10W		
R4A ,5A			RK73FB2A333J	CHIP R 33K J 1/10W		
R6A			RK73FB2A910J	CHIP R 91 J 1/10W		
R7A ,8A			RK73FB2A824J	CHIP R 820K J 1/10W		
R21A			RK73FB2A102J	CHIP R 1.0K J 1/10W		
R22A			RK73FB2A472J	CHIP R 4.7K J 1/10W		
R23A			RK73FB2A563J	CHIP R 56K J 1/10W		
R29A			RK73FB2A103J	CHIP R 10K J 1/10W	M	2
R29A			RK73FB2A103J	CHIP R 10K J 1/10W	M2	1
R29A			RK73FB2A822J	CHIP R 8.2K J 1/10W	M	3
R29A			RK73FB2A822J	CHIP R 8.2K J 1/10W	MM2	5
R30A			RK73FB2A000J	CHIP R 0 J 1/10W	M	2
R30A			RK73FB2A000J	CHIP R 0 J 1/10W	M2	1
R30A			RK73FB2A102J	CHIP R 1.0K J 1/10W	M	3
R30A			RK73FB2A102J	CHIP R 1.0K J 1/10W	MM2	5
R31A			RK73FB2A122J	CHIP R 1.2K J 1/10W		
R32A			RK73FB2A152J	CHIP R 1.5K J 1/10W		
R33A			RK73FB2A182J	CHIP R 1.8K J 1/10W		
R34A			RK73FB2A242J	CHIP R 2.4K J 1/10W		
R35A			RK73FB2A362J	CHIP R 3.6K J 1/10W		
R38A			RK73FB2A000J	CHIP R 0 J 1/10W	M	2
R38A			RK73FB2A000J	CHIP R 0 J 1/10W	M2	1
R38A			RK73FB2A821J	CHIP R 820 J 1/10W	M	3
R38A			RK73FB2A821J	CHIP R 820 J 1/10W	MM2	5
R39A			RK73FB2A221J	CHIP R 220 J 1/10W	M	3
R39A			RK73FB2A221J	CHIP R 220 J 1/10W	M	2
R39A			RK73FB2A221J	CHIP R 220 J 1/10W	MM2	5
R40A			RK73FB2A100J	CHIP R 10 J 1/10W	M2	1
R41A			RK73FB2A472J	CHIP R 4.7K J 1/10W		

L : Scandinavia K : USA P : Canada R : Mexico 1 : DPC-181 2 : DPC-183
 Y : PX(Far East, Hawaii) T : Europe E : Europe G : Germany 3 : DPC-381 4 : DPC-382
 Y : AAFES(Europe) X : Australia M : Other Areas 5 : DPC-383

⚠ indicates safety critical components.

* New Parts
 Parts without **Parts No.** are not supplied.
 Les articles non mentionnés dans le **Parts No.** ne sont pas fournis.
 Teile ohne **Parts No.** werden nicht geliefert.

6

Ref. No	Add-ress	New Parts	Parts No.	Description	Desti-nation	Re-marks
R42A			RK73FB2A472J	CHIP R 4.7K J 1/10W		
R43A			RK73FB2A103J	CHIP R 10K J 1/10W		
R45A			RK73FB2A393J	CHIP R 39K J 1/10W		
R46A			RK73FB2A100J	CHIP R 10 J 1/10W		
R47A			RK73FB2A100J	CHIP R 10 J 1/10W		
R49A			RK73FB2A100J	CHIP R 10 J 1/10W		
R51A			RK73FB2A122J	CHIP R 1.2K J 1/10W	M	3
R51A			RK73FB2A122J	CHIP R 1.2K J 1/10W	M	2
R51A			RK73FB2A122J	CHIP R 1.2K J 1/10W	MM2	5
R51A			RK73FB2A122J	CHIP R 1.2K J 1/10W	M2	1
R52A			RK73FB2A152J	CHIP R 1.5K J 1/10W	M	3
R52A			RK73FB2A152J	CHIP R 1.5K J 1/10W	M	2
R52A			RK73FB2A152J	CHIP R 1.5K J 1/10W	MM2	5
R52A			RK73FB2A152J	CHIP R 1.5K J 1/10W	M2	1
R54A			RK73FB2A223J	CHIP R 22K J 1/10W		
R55A			RK73FB2A103J	CHIP R 10K J 1/10W		
R56A			RK73FB2A223J	CHIP R 22K J 1/10W		
R57A			RK73FB2A224J	CHIP R 220K J 1/10W		
R58A			RK73FB2A103J	CHIP R 10K J 1/10W		
R59A			RK73FB2A333J	CHIP R 33K J 1/10W		
R60 ,61			RS14KB3A150J	FL-PROOF 15 J 1W		
R63A			RK73FB2A103J	CHIP R 10K J 1/10W		
R64A			RK73FB2A681J	CHIP R 680 J 1/10W		
R66A,67A			RK73FB2A103J	CHIP R 10K J 1/10W		
R68A			RK73FB2A473J	CHIP R 47K J 1/10W	M2	5
R69A			RK73FB2A104J	CHIP R 100K J 1/10W		
R70A,71A			RK73FB2A103J	CHIP R 10K J 1/10W		
R72A			RK73FB2A104J	CHIP R 100K J 1/10W		
R73A			RK73FB2A102J	CHIP R 1.0K J 1/10W		
R99A			RK73FB2A154J	CHIP R 150K J 1/10W		
R100A			RK73FB2A154J	CHIP R 150K J 1/10W		
R109A			RK73FB2A124J	CHIP R 120K J 1/10W		
R110A			RK73FB2A473J	CHIP R 47K J 1/10W		
R111A			RK73FB2A104J	CHIP R 100K J 1/10W		
R112A			RK73FB2A473J	CHIP R 47K J 1/10W		
R113A			RK73FB2A223J	CHIP R 22K J 1/10W		
R114A			RK73FB2A224J	CHIP R 220K J 1/10W		
R115A			RK73FB2A154J	CHIP R 150K J 1/10W		
R116A			RK73FB2A123J	CHIP R 12K J 1/10W		
R119A			RK73FB2A470J	CHIP R 47 J 1/10W		
R121A			RK73FB2A474J	CHIP R 470K J 1/10W		
R122A			RK73FB2A223J	CHIP R 22K J 1/10W		
R123A			RK73FB2A472J	CHIP R 4.7K J 1/10W		
R124A			RK73FB2A273J	CHIP R 27K J 1/10W		
R125A			RK73FB2A223J	CHIP R 22K J 1/10W		
R130A			RK73FB2A102J	CHIP R 1.0K J 1/10W		
R134A			RK73FB2A101J	CHIP R 100 J 1/10W		
R136A			RK73FB2A100J	CHIP R 10 J 1/10W		
R137A			RK73FB2A152J	CHIP R 1.5K J 1/10W		
R138A			RK73FB2A100J	CHIP R 10 J 1/10W		
R140A			RK73FB2A392J	CHIP R 3.9K J 1/10W		
R166A			RK73FB2A102J	CHIP R 1.0K J 1/10W		
R167A			RK73FB2A473J	CHIP R 47K J 1/10W		
R168A			RK73FB2A103J	CHIP R 10K J 1/10W		
R169A			RK73FB2A333J	CHIP R 33K J 1/10W		

L : Scandinavia K : USA P : Canada R : Mexico 1 : DPC-181 2 : DPC-183
 Y : PX(Far East, Hawaii) T : Europe E : Europe G : Germany 3 : DPC-381 4 : DPC-382
 Y : AAFES(Europe) X : Australia M : Other Areas 5 : DPC-383

⚠ indicates safety critical components.

PARTS LIST

DPC-181/183/381/382/383

* New Parts
Parts without **Parts No.** are not supplied.
Les articles non mentionnés dans le **Parts No.** ne sont pas fournis.
Teile ohne **Parts No.** werden nicht geliefert.

7

Ref. No	Add-ress	New Parts	Parts No.	Description	Desti-nation	Re-marks
R170A			RK73FB2A562J	CHIP R 5.6K J 1/10W		
R171A			RK73FB2A104J	CHIP R 100K J 1/10W		
R172A			RK73FB2A153J	CHIP R 15K J 1/10W		
R173A			RK73FB2A682J	CHIP R 6.8K J 1/10W		
R174A			RK73FB2A682J	CHIP R 6.8K J 1/10W		
R175A			RK73FB2A122J	CHIP R 1.2K J 1/10W		
R177A			RK73FB2A473J	CHIP R 47K J 1/10W		
R178A			RK73FB2A104J	CHIP R 100K J 1/10W		
R179A			RK73FB2A105J	CHIP R 1.0M J 1/10W		
R180A			RK73FB2A473J	CHIP R 47K J 1/10W		
R181A			RK73FB2A681J	CHIP R 680 J 1/10W		
R182A			RK73FB2A471J	CHIP R 470 J 1/10W		
R183A			RK73FB2A101J	CHIP R 100 J 1/10W		
R184A			RK73FB2A224J	CHIP R 220K J 1/10W		
R189A			RK73FB2A103J	CHIP R 10K J 1/10W		
R201A			RK73FB2A102J	CHIP R 1.0K J 1/10W		
R202A			RK73FB2A473J	CHIP R 47K J 1/10W		
R203A			RK73FB2A104J	CHIP R 100K J 1/10W		
R204A			RK73FB2A821J	CHIP R 820 J 1/10W		
R206A			RK73FB2A153J	CHIP R 15K J 1/10W		
R207A			RK73FB2A564J	CHIP R 560K J 1/10W		
R209A			RK73FB2A100J	CHIP R 10 J 1/10W		
R210A			RK73FB2A104J	CHIP R 100K J 1/10W		
R211A			RK73FB2A681J	CHIP R 680 J 1/10W		
R220A			RK73FB2A562J	CHIP R 5.6K J 1/10W		
R221A			RK73FB2A471J	CHIP R 470 J 1/10W		
R222A			RK73FB2A472J	CHIP R 4.7K J 1/10W		
R301A			RK73FB2A102J	CHIP R 1.0K J 1/10W		
R302A			RK73FB2A473J	CHIP R 47K J 1/10W		
R303A			RK73FB2A104J	CHIP R 100K J 1/10W		
R304A			RK73FB2A821J	CHIP R 820 J 1/10W		
R306A			RK73FB2A153J	CHIP R 15K J 1/10W		
R307A			RK73FB2A564J	CHIP R 560K J 1/10W		
R309A			RK73FB2A100J	CHIP R 10 J 1/10W		
R310A			RK73FB2A104J	CHIP R 100K J 1/10W		
R311A			RK73FB2A681J	CHIP R 680 J 1/10W		
R320A			RK73FB2A562J	CHIP R 5.6K J 1/10W		
R321A			RK73FB2A471J	CHIP R 470 J 1/10W		
R322A			RK73FB2A472J	CHIP R 4.7K J 1/10W		
R401A			RK73FB2A223J	CHIP R 22K J 1/10W		
R501A			RK73FB2A683J	CHIP R 68K J 1/10W		
R502A			RK73FB2A104J	CHIP R 100K J 1/10W		
VR101			R31-0086-08	VARIABLE RESISTOR		
SW101-106		*	S70-0053-08	TACT SWITCH		
SW107,108		*	S62-0064-08	SLIDE SWITCH		
SW109		*	S74-0082-08	MICRO SWITCH		
D1A			1SS355	DIODE		
D102A			1SS355	DIODE		
D104		*	SB10-03A3-BT	DIODE		
D111,112			IN-4001	DIODE		
D115			GMB01-BT	DIODE		
D115		*	SB10-03A3-BT	DIODE	M2	3,5
D116			GMB01-BT	DIODE		
D117			GMB01-BT	DIODE	M2	

L : Scandinavia K : USA P : Canada R : Mexico 1 : DPC-181 2 : DPC-183
Y : PX(Far East, Hawaii) T : Europe E : Europe G : Germany 3 : DPC-381 4 : DPC-382
V : AAFES(Europe) X : Australia M : Other Areas 5 : DPC-383

⚠ indicates safety critical components.

* New Parts
Parts without **Parts No.** are not supplied.
Les articles non mentionnés dans le **Parts No.** ne sont pas fournis.
Teile ohne **Parts No.** werden nicht geliefert.

8

Ref. No	Add-ress	New Parts	Parts No.	Description	Desti-nation	Re-marks
D117			GMB01-BT	DIODE	M	3
D117			GMB01-BT	DIODE	MM2	5
D117			GMB01-BT	DIODE	M2	1
D119A-122A			1SS355	DIODE		
D201A			1SS355	DIODE		
D301A			1SS355	DIODE		
IC1			AN8806SB	IC(GD DIGITAL SERVO)		
IC2			AN8819NFB	IC		
IC3		*	MN171603HFC	IC		
IC4			MN662740RE	IC		
IC5		*	SM5859AF	IC		3,4,5
IC6			MN41V4400SJ-07	IC		3,4,5
IC6		*	MN41V4400SJ-08	IC		3,4,5
IC7			NJM2073M	IC(AF POWER AMP)		
Q4			2SC3330	TRANSISTOR		
Q5			2SA1317	TRANSISTOR		
Q6			2SC3330	TRANSISTOR		
Q102			2SB598F	TRANSISTOR		
Q104			2SA1317	TRANSISTOR		
Q106		*	2SC4481T	TRANSISTOR		
Q107		*	2SC4048-AC	TRANSISTOR		
Q108		*	2SD1805F	TRANSISTOR		
Q108		*	2SD1805G	TRANSISTOR		
Q109			2SC4204	TRANSISTOR		
Q110			2SA1317	TRANSISTOR		
Q111,112			2SB926T	TRANSISTOR		
Q113			2SA1317	TRANSISTOR		
Q201			2SC3330	TRANSISTOR		
Q202			2SD734F	TRANSISTOR		
Q203		*	2SC3860	TRANSISTOR		
Q205A			2SC3859	TRANSISTOR		
Q301			2SC3330	TRANSISTOR		
Q302			2SD734F	TRANSISTOR		
Q303		*	2SC3860	TRANSISTOR		
Q304			2SC3330	TRANSISTOR	M2	5
Q305A			2SC3859	TRANSISTOR		
J104		*	W02-2630-08	OPTICAL OUT 3.6MM(7 PINS)	M2	3,5

L : Scandinavia K : USA P : Canada R : Mexico 1 : DPC-181 2 : DPC-183
Y : PX(Far East, Hawaii) T : Europe E : Europe G : Germany 3 : DPC-381 4 : DPC-382
V : AAFES(Europe) X : Australia M : Other Areas 5 : DPC-383

⚠ indicates safety critical components.

PARTS LIST

DPC-181/183/381/382/383

DPC-181/183/381/382/383

SPECIFICATIONS

[Format]

SystemCompact disc digital audio system
 LaserSemiconductor laser

[Audio]

Frequency response20 Hz to 20 kHz, ± 3 dB
 PHONES output level (16 Ω , 1 kHz)10 mW + 10 mW
 Line output/impedance0.6 Vrms/1 k Ω
 Digital output (Optical) *-15dBm to ~ 21dBm (wave length 660 nm)

* M2 type only except DPC-181.

[Power supply]

External DC supply4.5V to 6 V DC
 Rechargeable batteries (NB-88) x 2 or 4DC 2.4 V
 Commercially-available alkaline batteries (LR6/AA) x 2 or 4DC 3 V

Battery life (continuous repeat playback)

(Figures inside parentheses show the performance when the D.A.S.C. is ON.)

Commercially-available alkaline batteries (LR6/AA) x 2Approx. 10 (8) Hours (DPC-382/381/383)
 Commercially-available alkaline batteries (LR6/AA) x 2Approx. 10 Hours (DPC-181/183)
 Commercially-available alkaline batteries (LR6/AA) x 4Approx. 20 (17.5) Hours (DPC-382/381/383)
 Commercially-available alkaline batteries (LR6/AA) x 4Approx. 20 Hours (DPC-181/183)
 Rechargeable batteries (NB-88) x 2Approx. 4 (3) Hours (DPC-382/381/383)
 Rechargeable batteries (NB-88) x 2Approx. 4 Hours (DPC-181/183)
 Rechargeable batteries (NB-88) x 4Approx. 9 (6) Hours (DPC-382/381/383)
 Rechargeable batteries (NB-88) x 4Approx. 9 Hours (DPC-181/183)

Dimensions (W x H x D)138 mm x 30 mm x 157 mm
 (5-7/16" x 1-3/16" x 6-3/16")

Dimensions (W x H x D)140 mm x 31 mm x 159 mm
 (5-1/2" x 1-1/4" x 6-1/8")

Weight (net)270 g (9.5 oz): DPC-181/381/382

Weight (net)280 g (9.9 oz): DPC-183/383

Note:

KENWOOD follows a policy of continuous advancements in development. For this reason specifications may be changed without notice.

DPC-181/183/381/382/383

Note:

Component and circuit are subject to modification to insure best operation under differing local conditions. This manual is based on Europe (E) standard, and provides information on regional circuit modification through use of alternate schematic diagrams, and information on regional component variations through use of parts list.

KENWOOD CORPORATION

14-6, Dogenzaka 1-chome, Shibuya-ku, Tokyo, 150 Japan

KENWOOD SERVICE CORPORATION

P.O. BOX 22745, 2201 East Dominguez St., Long Beach, CA 90801-5745, U.S.A.

KENWOOD ELECTRONICS CANADA INC.

6070 Kestrel Road, Mississauga, Ontario, Canada L5T 1S8

KENWOOD ELECTRONICS LATIN AMERICA S.A.

P.O. BOX 55-2791, Piso 6 plaza Chase, Cl. 47 y Aquilino de la Guardia Panama, Republic de Panama

KENWOOD ELECTRONICS U.K. LIMITED

KENWOOD House, Dwight Road, Watford, Herts., WD1 8EB., United Kingdom

KENWOOD ELECTRONICS BENELUX N.V.

Meachelsesteenweg 418, B-1930 Zaventem, Belgium

KENWOOD ELECTRONICS DEUTSCHLAND GMBH

Rembrücker Str. 15, 63150 Heusenstamm, Germany

KENWOOD ELECTRONICS FRANCE S.A.

13 Boulevard Ney, 75018 Paris, France

KENWOOD ELECTRONICS ITALIA S.p.A.

Via G. Sirtori, 7/9 20129, Milano, Italy

KENWOOD IBÉRICA S.A.

Bolivia, 239-08020 Barcelona, Spain

KENWOOD ELECTRONICS AUSTRALIA PTY. LTD.

(A.C.N. 001499 074)

P.O. Box 504, 8 Figtree Drive, Australia Centre, Homebush, N.S.W. 2140, Australia

KENWOOD & LEE ELECTRONICS, LTD.

Unit 3712-3724, Level 37, Tower 1, Metroplaza, 223 Hing Fong Road, Kwai Fong N.T., Hong Kong

KENWOOD ELECTRONICS GULF FZE

P.O. Box 61318, Jebel Ali, Dubai, U.A.E.

KENWOOD ELECTRONICS SINGAPORE PTE LTD.

No. 1 Genting Lane #02-02, KENWOOD Building, Singapore, 349544

KENWOOD ELECTRONICS (MALAYSIA) SDN BHD.

#4.01 Level 4, Wisma Academy Lot 4A, Jalan 19/1 46300 Petaling Jaya Selangor Darul Ehsan Malaysia